



OVERFIX[®]

TRAUMA

SURGICAL TECHNIQUE

PROXIMAL FEMORAL NAIL

RAMIC

Intramedullary Nail Systems

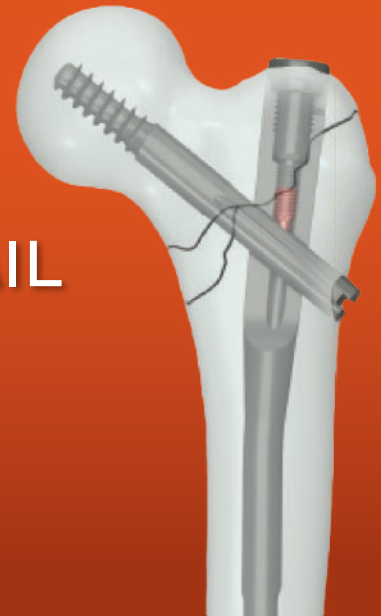

bioadvance

MEDICAL DEVICES

CONTENTS

Introduction	02
Features & Benefits	02
Indications & Contraindications	03
Surgical technique	04
1. Patient Positioning	04
2. Reduce Fractures	04
3. Confirm Nail Length and Diameter	04
4. Incision	05
5. Determine Entry Point	05
6. Insert Guide Wire	06
7. Open Femur	06
8. Assemble Proximal Femoral Nail and Insert Handle	07
9. Insertion of Proximal Femoral Nail	07
10. Insert Guide Wire	08
11. Insert Anti-rotation Wire	09
12. Measure Femoral Hip Screw Length	09
13. Open Lateral Cortex for Femoral Hip Compression Screw Insertion	10
14. Drill hole for Femoral Hip Compression Screw	10
15. Assemble Femoral Hip Compression Screw-A	11
16. Insert Femoral Hip Compression Screw-A	11
17. If Compression is Necessary	12
18. Remove Protection Sleeve for Lag Screw	12
19. Static distal Locking	13
20. Dynamic Distal Locking	14
21. Insert Femoral Locking Screws	14
22. Remove Insertion Handle from Proximal Femoral Nail	14
23. Insert Proximal Femoral End Caps	15
Surgical Technique for Femoral Compression Screw B	15
15. Tapping	15
16. Insert Femoral Compression Screw-B and Compression	16
17. Insert the Fastening Screw	16
Implant Removal	17
1. Remove Femoral Hip Compression Screw	17
2. Remove Proximal Femoral End Caps	17
3. Remove Femoral Locking Screws	18
4. Remove Proximal Femoral Nail	18
Surgical Technique for PFNA-long	19
Implants	21
Instruments	24

RAMIC · PROXIMAL FEMORAL NAIL

INTRAMEDULLARY NAIL SYSTEMS

INTRODUCTION

Ramic Proximal Femoral Nail system includes short PFN and long PFN, which can meet more indications. It designs two kinds of lag screws, both have the compression function.

FEATURES & BENEFITS

PROXIMAL FEMORAL NAIL

- » The anatomical design guarantees an optimal fit in the femur.
- » The medial-lateral angle of 5° allows insertion at the tip of the greater trochanter.
- » The cannulated nail facilitates easy insertion.

Two proximal locking screws available for surgeons option, both can make compression.

FEMORAL HIP COMPRESSION SCREWS-A

- » Rotational and angular stability achieved with one single element.
- » Provide compression for cancellous bone.
- » Locking device inside controls rotational stability of helical blade and femoral caput.

FEMORAL HIP COMPRESSION SCREWS-B

- » Self-retaining Fastening Screw to protect the Lag Screw against rotation and simultaneously allowing sliding of the Lag Screw laterally.
- » Cancellous screw design to provide better bone purchase, easy for compression.

Notes: For young patients or patients with good bone quality, Femoral Hip Compression Screw Bis highly recommended for easy removal after healing.



RAMIC · PROXIMAL FEMORAL NAIL

INTRAMEDULLARY NAIL SYSTEMS

INDICATIONS & CONTRAINDICATIONS

SHORT PROXIMAL FEMORAL NAIL

INDICATIONS

- » Inter-trochanteric fractures
- » Per-trochanteric fractures
- » Sub-trochanteric fractures
- » Nonunion and malunion

CONTRAINDICATIONS

- » Medial neck fractures



LONG PROXIMAL FEMORAL NAIL

INDICATIONS

- » Inter-trochanteric fractures
- » Sub-trochanteric fractures
- » Per-trochanteric fractures associated with shaft fractures
- » Pathological fractures (including prophylactic use) in both trochanteric and diaphyseal areas
- » Nonunion and malunion

CONTRAINDICATIONS

- » Medial neck fractures



RAMIC · PROXIMAL FEMORAL NAIL

SURGICAL TECHNIQUE

1. PATIENT POSITIONING

The patient is placed in a supine position on the extension table. Abduct the un-affected leg as far as possible to make room for the image intensifier. Maintaining traction, the injured leg is internally rotated 10 degrees to complete the proximal fractures reduction.



2. REDUCE FRACTURES

Closed reduction of the fracture is recommended. Reduction should be achieved as anatomically as possible. If this is not achievable in a closed procedure, open reduction may be necessary. The large distractor may be used in some certain fractures.

3. CONFIRM NAIL LENGTH AND DIAMETER

Use the radiographic ruler for short and long nails to estimate nail diameter and nail length. To estimate nail diameter, place the radiographic ruler on the AP of lateral X-ray of the uninjured femur and measure the diameter of the medullary canal at the narrowest part.

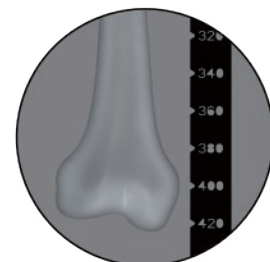
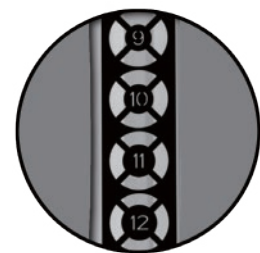

RAMIC · PROXIMAL FEMORAL NAIL

SURGICAL TECHNIQUE

To estimate nail length, place the radiographic ruler on the AP X-ray of the uninjured femur and select the appropriate nail length based on patient anatomy.

4. INCISION

The tip of the greater trochanter can be located by palpation, and a horizontal skin incision of approximately 4-5cm is made from the greater trochanter in the direction of the iliac crest, deep to the bone.

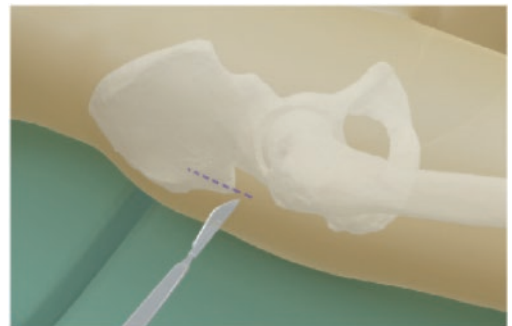

5. DETERMINE ENTRY POINT

In AP view, the entry point is on the tip of the greater trochanter in lateral view, the entry point is on the junction of the anterior third and posterior two-thirds of the tip of the greater trochanter.



RAMIC · PROXIMAL FEMORAL NAIL

SURGICAL TECHNIQUE

6.INSERT GUIDE WIRE

Position both Entry Drill Guide (13031001) and Entry Drill Sleeve for Guide Wire (13031002) at the determined entry point.

Insert $\phi 3.2$ Threaded Guide Wire (13030003) through the Entry Drill sleeve for Guide wire. Then remove the Entry Drill sleeve for Guide wire.



Entry Drill Guide (13031001)



Entry Drill Sleeve for Guide Wire (13031002)



$\phi 3.2$ Threaded Guide Wire (13030003)

7.OPEN FEMUR

Insert Entry Reamer, Cannulated (13031003) through Entry Drill Guide over $\phi 3.2$ Guide Wire-B (13030059) and drill with Universal Chuck with Electric tools as far as the stopper on Entry Drill Guide (13031001). Remove Entry Drill Guide and the Entry Drill Guide and $\phi 3.2$ guide wire-B.



Entry Reamer, Cannulated (13031003)

RAMIC · PROXIMAL FEMORAL NAIL

SURGICAL TECHNIQUE

8.ASSEMBLE PROXIMAL FEMORAL NAIL AND INSERT HANDLE

Assemble the pre-determined Proximal Femoral Nail onto the Insertion Handle (13031004), secure it with the Locking Bolt (13031005) using Hexagonal Screwdriver with spheral head, SW7 (13030033)



NOTE: Ensure that the connection between Proximal Femoral Nail and Insertion Handle is tight enough to make accurate targeting.



Insertion Handle (13031004)



Locking Bolt (13031005)



Hexagonal Screwdriver with spheral head, SW7 (13030033)

9.INSERTION OF PROXIMAL FEMORAL NAIL

Carefully insert the Proximal Femoral Nail manually as far as possible into the femoral canal. Slight twisting hand movements help insertion. If manually insertion can not make it, place Impactor (13030019) onto the Insertion Handle. Lightly blow with Combined Hammer (13030047) to insert the nail.



NOTE: Use only light blows by way of avoiding unnecessary use of force to prevent loss of reduction or an iatrogenic fracture.



Impactor (13030019)



Combined Hammer (13030047)

RAMIC · PROXIMAL FEMORAL NAIL

SURGICAL TECHNIQUE

10.INSERT GUIDE WIRE

Assemble the Proximal Aiming Device (13031006) device and fix it firmly to the Insertion Handle (13031004). Insert Drill sleeve for $\varphi 3.2$ Guide Wire (13031014) and Trocar $\varphi 3.2$ (13031015) through the Protection Sleeve for Lag Screw (13031008). Pass the entire assembly through the Proximal Aiming Device (13031006) to the level of skin. This indicates the position for a small incision down to the bone. The guide sleeve assembly is now advanced through the incision till to the bone.

Remove the Trocar $\varphi 3.2$. Insert a $\varphi 3.2$ Threaded Guide-B direction and position under intensifier in both AP and Lateral view.

In AP view, the guide wire is inserted subchondrally into the femoral head at a distance of 5-10mm below the joint level. It should be placed in the lower half of the femoral head.

In the lateral view, the guide wire should be in the center of the femoral head.

NOTE: The Protection Sleeve for Lag Screw (13031008) assembly must be in contact with the bone during the entire Femoral Hip Compression Screws implantation.

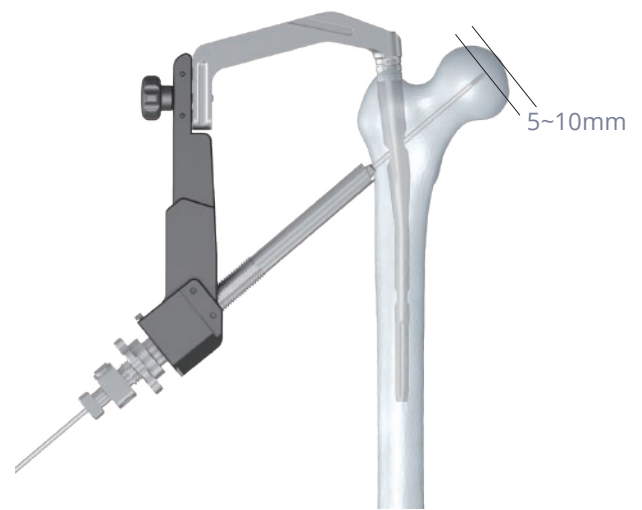
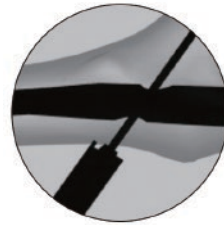

Protection Sleeve for Lag Screw (13031008)



Drill sleeve for $\varphi 3.2$ Guide Wire (13031014)



Trocar, $\varphi 3.2$ (13031015)



$\varphi 3.2$ Threaded Guide Wire-B (13030059)

RAMIC · PROXIMAL FEMORAL NAIL

SURGICAL TECHNIQUE

11. INSERT ANTI-ROTATION WIRE

If the femoral neck is broken, strongly recommend to insert anti-rotation wire first, which can prevent the axial rotation of femoral head caused by following steps.

Put the Aiming Jig for Anti-rotation Wire (13031012) on the Proximal Aiming Device, 130° (13031006). The hexagonal part is on the lateral side. Insert $\phi 3.2$ Threaded Guide Wire-B (13030059) along the Drill sleeve (13031013).

NOTE: Optional step for Femoral Compression Screw A. But necessary step for Femoral Compression Screw B.

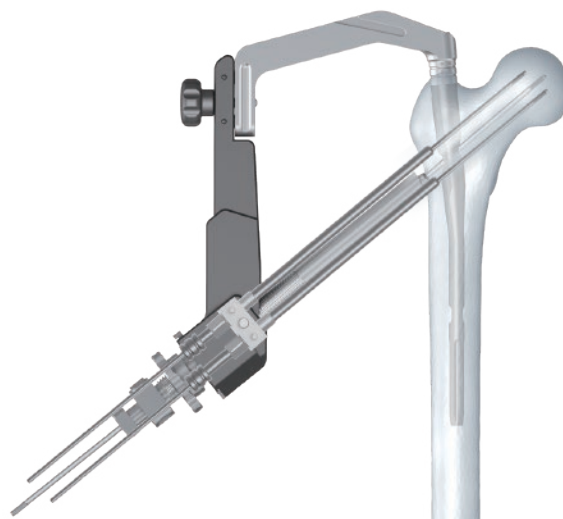

12. MEASURE FEMORAL HIP SCREW LENGTH

If the femoral neck is broken, strongly recommend to insert anti-rotation wire first, which can prevent the axial rotation of femoral head caused by following steps.

Put the Aiming Jig for Anti-rotation Wire (13031012) on the Proximal Aiming Device, 130° (13031006). The hexagonal part is on the lateral side. Insert $\phi 3.2$ Threaded Guide Wire-B (13030059) along the Drill sleeve (13031013).



Depth Gauge for Lag Screw (13031016)

RAMIC · PROXIMAL FEMORAL NAIL

SURGICAL TECHNIQUE

13.OPEN LATERAL CORTEX FOR FEMORAL HIP COMPRESSION SCREW INSERTION

Carefully remove Drill sleeve for $\phi 3.2$ Guide Wire (13031014) without changing the position of the $\phi 3.2$ Threaded Guide Wire-B (13030059). Push Drill Bit for Opening Proximal Cortical Bone, Cannulated (13031017) over $\phi 3.2$ Threaded Guide Wire-B, and drill to the stopper. This opens the lateral cortex.

NOTE: If the Guide Wire has been bent slightly during insertion, guide the Drill Bit for Opening Proximal cortical bone, Cannulated (13031017) over it using carefully forward and backward movements. If the Guide Wire has been bent to a greater extent reinsert it or replace it by a new Guide Wire. Otherwise, the tip of the Drill Bit for Opening Proximal cortical bone, Cannulated risks to break off.

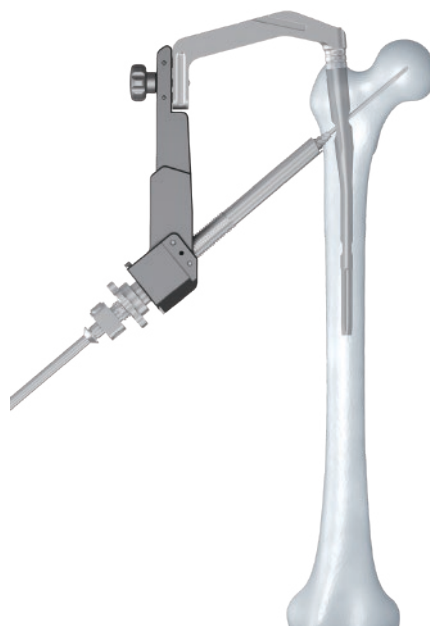

Drill sleeve for $\phi 3.2$ Guide Wire (13031014)



Protection Sleeve for Lag Screw (13031008)



Drill Bit for Opening Proximal Cortical Bone, Cannulated (13031017)

14.DRILL HOLE FOR FEMORAL HIP COMPRESSION SCREW

Set the measured length of Femoral Hip Compression Screw on the Proximal Reamer, Cannulated (13031018) in the corresponding position. Read off the correct length on the side of the stopper pointing towards the tip of the Drill Bit. Push the reamer over $\phi 3.2$ Threaded Guide Wire-B (13030059) and drill to the stopper.



Proximal Reamer, Cannulated (13031018)

NOTE: For Osteoporosis patients, Drill Bit for opening Proximal cortical bone, Cannulated (13031017) is applied to drill the hole.



Drill Bit for Opening Proximal Cortical Bone, Cannulated (13031017)

RAMIC · PROXIMAL FEMORAL NAIL

SURGICAL TECHNIQUE

15.ASSEMBLE FEMORAL HIP COMPRESSION SCREW-A

The Femoral Hip Compression Screws-A is supplied in a locked state. Use slight anticlockwise pressure to insert the Impactor for Lag screws-A, Cannulated (13031019) into the selected Femoral Hip Compression Screws-A to the stopper. Then the blade rotates freely.



Impactor for Lag screws-A, Cannulated (13031019)

Lock

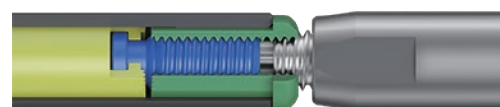

Loose

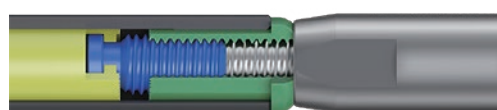

16.INSERT FEMORAL HIP COMPRESSION SCREW-A

In view of the particular shape of Femoral Hip Compression Screws-A, align it With the Protection Sleeve for Lag Screw (13031008) (see marking on the Protection Sleeve). Insert both Femoral Hip Compression Screws-A and Impactor for Lag screws-A, Cannulated (13031019) over the $\phi 3.2$ Threaded Guide Wire-B (13030059) through Protection Sleeve for Lag Screw until the Impactor snaps into the Protection Sleeve. Insert the Femoral Hip Compression Screws-A to the stopper by hammering lightly with the Combined Hammer (13030047). Turn the Impactor for Lag screws-A, Cannulated clockwise to the stopper. Verify Femoral Hip Compression Screws-A locking intraoperatively that all gaps of Femoral Hip Compression Screws-A are closed. Press the button on the Protection Sleeve for Lag Screw to remove the Impactor. Remove the Impactor for Lag screws-A, Cannulated (13031019) and $\phi 3.2$ Threaded Guide Wire-B (13030059).

NOTE: Do not use unnecessary force when inserting the Femoral Hip Compression Screws-A. If the Femoral Hip Compression Screws-A cannot be locked, remove it and replace it by a new Femoral Hip Compression Screws-A.

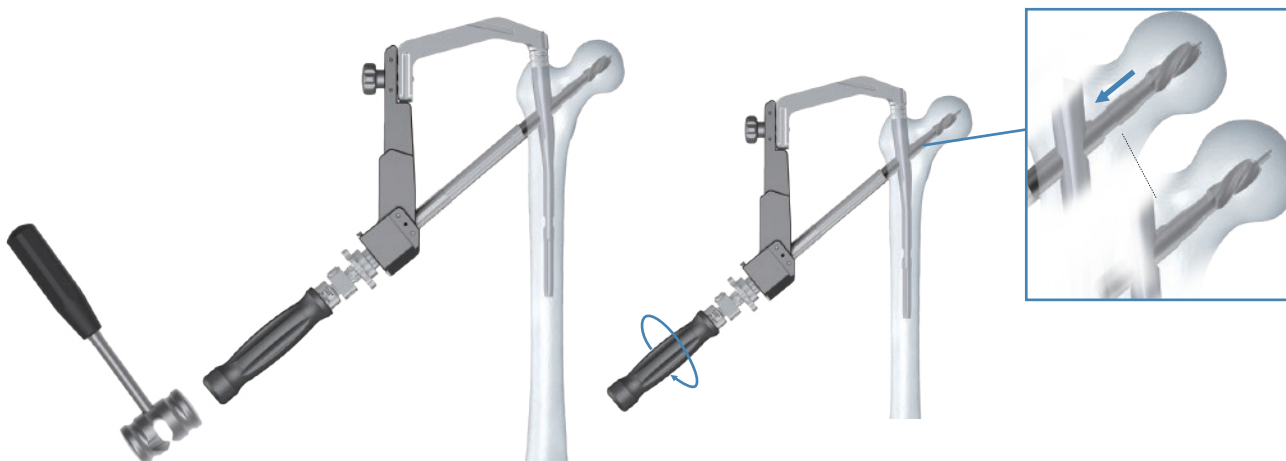

RAMIC · PROXIMAL FEMORAL NAIL

SURGICAL TECHNIQUE

17. IF COMPRESSION IS NECESSARY

Remove the Impactor for Lag screws-A, Cannulated (13031019), insert the Compression Instrument for Blade (13031010). Rotate it anticlockwise until it is closely connected with compression screw. Then slightly rotate the nut anticlockwise to make compression.

NOTE: Only slightly rotation is allowed. Patients with severe Osteoporosis is not recommended to make compression.



Compression Instrument for Blade (13031010)



Impactor for Lag screws-A, Cannulated (13031019)

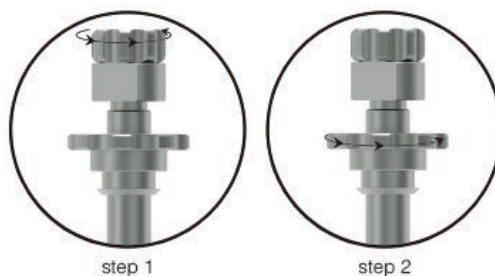

18. REMOVE PROTECTION SLEEVE FOR LAG SCREW

Release and remove the Protection Sleeve for Lag Screw (13031008) by pressing the button on the Proximal Aiming Device (13031006).



RAMIC · PROXIMAL FEMORAL NAIL

SURGICAL TECHNIQUE

19.STATIC DISTAL LOCKING

Insert the Sleeve for Locking Screw (13030034) Sleeve for Drill Bit (13030035) Protector, $\varphi 4$ (13030036) through the static locking hole in the Proximal Aiming Device (13031006) to the skin. Then make a stab incision at the tip of Protector, $\varphi 4$. Then promote the Sleeve for Locking Screw, Sleeve for Drill Bit, Protector, assembly to the cortex. Remove Protector, $\varphi 4$ and use the Drill, $\varphi 4$ (13030038) to drill through both cortices. Remove the Drill, $\varphi 4$ and Sleeve for Drill Bit. Determine the length of Femoral Locking Screws with the Depth Gauge for Locking Bolt (13030040). Advance the Depth Gauge for Locking Bolt to the cortex. Then draw back the hook until it engages in the opposite cortex. Remove the Depth Gauge for Locking Bolt.



Sleeve for Locking Screw (13030034)



Sleeve for Drill Bit (13030035)



Protector, $\varphi 4$ (13030036)



Drill, $\varphi 4$ (13030038)



Depth Gauge for Locking Bolt (13030040)



Proximal Aiming Device (13031006)

NOTE: Always make sure that no diastasis has occurred intraoperatively before beginning distal locking. Diastasis can cause delayed healing.

Always ensure that the connection between Proximal Aiming Device (13031006) and Insertion Handle (13031004) is good, otherwise reaming for the distal locking bolt can damage the Proximal Femoral Nail.

RAMIC · PROXIMAL FEMORAL NAIL

SURGICAL TECHNIQUE

20. DYNAMIC DISTAL LOCKING

Remove the Proximal Aiming Device (13031006) and mount the Aiming Arm for dynamic locking (13031009). Proceed as described in step 19.



21. INSERT FEMORAL LOCKING SCREWS

Insert the Femoral Locking Screws through the Sleeve for Locking Screw (13030034) using Stardrive Wrench, Quick Coupling, $\phi 5.6$ (13030041). Then remove the Sleeve for Locking Screw.



Sleeve for Locking Screw (13030034)



Stardrive Wrench, Quick Coupling, $\phi 5.6$ (13030041)



Quick Handle (13030006)

22. REMOVE INSERTION HANDLE FROM PROXIMAL FEMORAL NAIL

Remove the Aiming Device. Use Hexagonal Screwdriver with spherical head, SW7 (13030033) to Loosen the Locking Bolt (13031005) and remove the Insertion Handle (13031004).

RAMIC · PROXIMAL FEMORAL NAIL

SURGICAL TECHNIQUE

23.INSERT PROXIMAL FEMORAL END CAPS

Insert the Guide Wire for End Cap (13030053) through the selected proximal femoral end caps. Then guide Flexible Screwdriver for End Cap (13030052) over the Guide Wire for End Cap. The Proximal Femoral End Caps is retained automatically as soon as this connection is established. Use the Combined Wrench (13030048) to secure the proximal femoral end caps. Fully insert the Proximal Femoral End Caps into the nail.

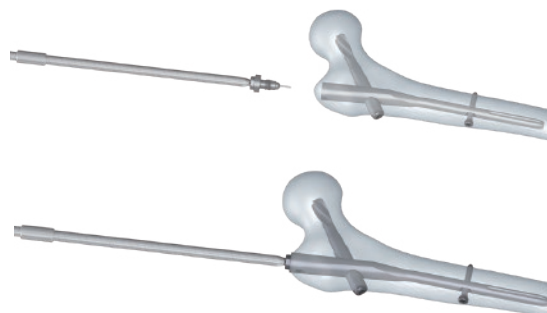

Guide Wire for End Cap (13030053)



Quick Handle (13030006)



Flexible Screwdriver for End Cap (13030052)

SURGICAL TECHNIQUE FOR FEMORAL COMPRESSION SCREW B

STEP 1 TO 14, SAME WITH FEMORAL COMPRESSION SCREW A

15.TAPPING

Connect Tap for Lag Screws-B (13031023) and Quick Handle (13030006). Tapping depth is same as the lag screw length or at least 2-5mm less than lag screw length.

For osteoporosis (70 years older patients), in order to keep bone purchase, please do not tap and directly insert the lag screw.



RAMIC · PROXIMAL FEMORAL NAIL

SURGICAL TECHNIQUE

16. INSERT FEMORAL COMPRESSION SCREW-B AND COMPRESSION

Assemble the Femoral Compression Screw-B on the Screwdriver (13031024).

Before inserting the Femoral Compression Screw-B, check the fracture gap of femoral neck first. If the gap is more than 5mm, compression is needed. If the femoral neck is OK or reduction is good, then no need to do compression.

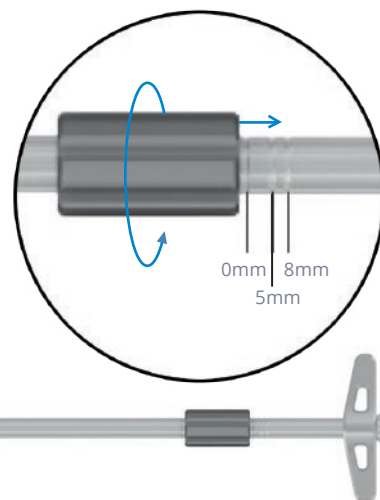

Three circles exist beside the black thumbwheel, respectively standing for 0mm, 5mm, and 8mm compression distance. Take 5mm compression as example. Screw the thumbwheel to the 5mm circle position. After totally inserting the Femoral Compression Screw B, then rotate the thumbwheel clockwise until the black thumbwheel flush with 0mm line. The longest compression distance is 8mm. More than 8mm compression may cause fracture bone collapse.

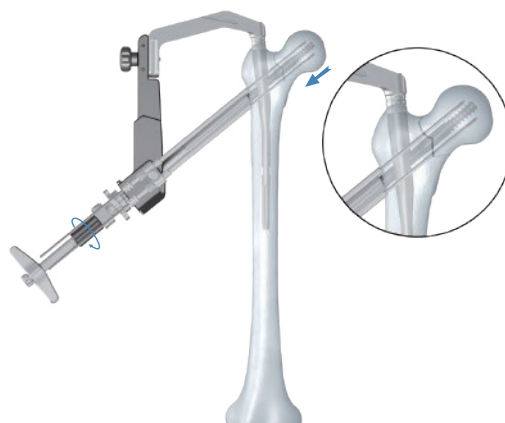

After inserting screw, the handle of Screwdriver (13031024) should be 0° or 90° perpendicular to the Proximal Aiming Device, 135° (13031007). So that the Fastening Screw would be able to sit exactly on one of the four grooves of the Femoral Compression Screw.



Screwdriver for Lag Screws-B (13031024)

17. INSERT THE FASTENING SCREW

Insert the Fastening Screw through the hole of locking bolt by using Flexible Screwdriver, $\Phi 4.6$ (13031032).

The remaining procedures are same as Femoral Compression Screw A.

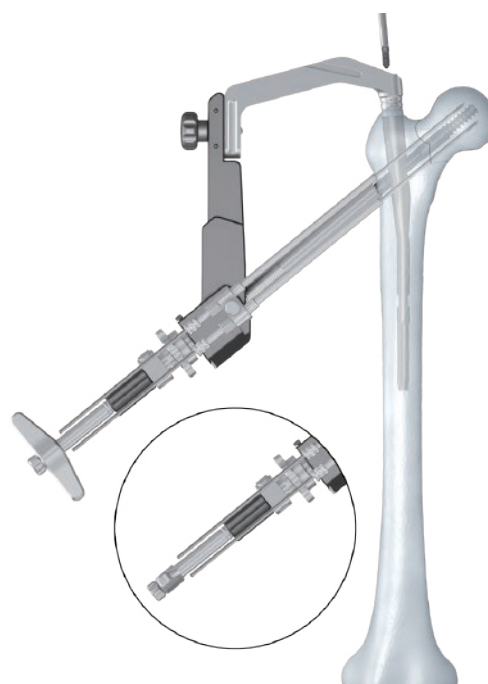

RAMIC · PROXIMAL FEMORAL NAIL

SURGICAL TECHNIQUE

IMPLANT REMOVAL

1.REMOVE FEMORAL HIP COMPRESSION SCREW

After an incision through the old scars, locate the Femoral Hip Compression Screws-A by palpation or under image intensification. Push the Extractor for Lag Screws-A (13031020) and use gentle pressure to turn it anticlockwise into Femoral Hip Compression Screws-A. Use light hammer blows with the Combined Hammer (13030047) to remove and dispose of Femoral Hip Compression Screws-A.



Extractor for Lag Screws-A (13031020)



Combined Hammer (13030047)



Remove Femoral Hip Compression Screw-A



Remove Femoral Hip Compression Screw-B

2.REMOVE PROXIMAL FEMORAL END CAPS

Remove bone scar and soft tissue over the end cap. Remove the end cap with a optional instrument Flexible Screwdriver, $\varnothing 5.6$ (13030054).



Flexible Screwdriver, $\varnothing 5.6$ (13030054) option

RAMIC · PROXIMAL FEMORAL NAIL

SURGICAL TECHNIQUE

3.REMOVE FEMORAL LOCKING SCREWS

Attach the Extractor for Intramedullary Nail (13031022) to Proximal Femoral Nail firmly. Thereafter an incision through the old scars, use Stardrive Wrench, Quick Coupling, $\varphi 5.6$ (13030041) to remove the Femoral Locking Screws.



Extractor for Intramedullary Nail (13031022)



Stardrive Wrench, Quick Coupling, $\varphi 5.6$ (13030041)

4.REMOVE PROXIMAL FEMORAL NAIL

Attach the Combined Hammer (13030047) to the Extractor for Intramedullary Nail (13031022) to remove the Proximal Femoral Nail. Use Combined Hammer blows to extract Proximal Femoral Nail from the femur.

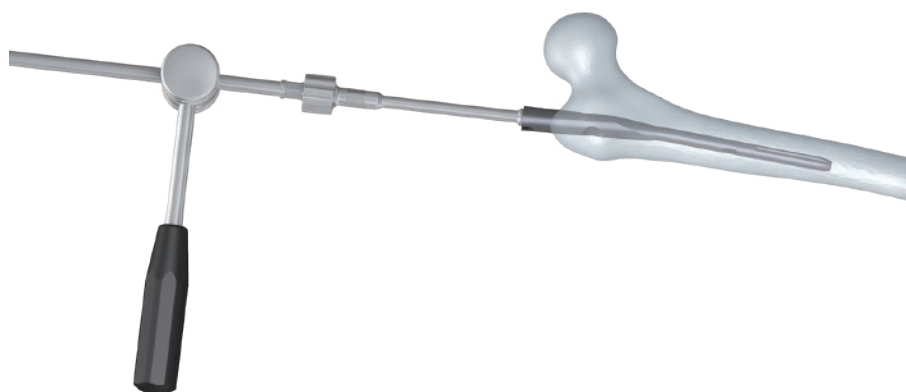

RAMIC · PROXIMAL FEMORAL NAIL

SURGICAL TECHNIQUE

SURGICAL TECHNIQUE FOR PFNA-LONG

STEP 1-7, SAME AS PFNA-SHORT

8.INSERT GUIDE WIRE WITH SPHERAL HEAD, Ø2.5

For simple fracture, just insert the Guide Wire (13030008) passing through the fracture area to the distal femur with the help of Guide Wire Gripper (13030058).

For complicated comminuted fracture, in order to insert the Guide Wire (13030008) smoothly, Instrument for Closed Reduction (13030007) is recommended to be used firstly.

NOTE: Insert the Closed Reduction (13030007) into the canal while keeping handle towards the medial side, so that to reduce the stress on lateral femur. Pass through the fracture area to distal femur. Then insert the Guide Wire (13030008).



9.REAM MEDULLARY CANAL

Connect Flexible Reamer Shaft (13030009) with reamer head. Start from 9mm reamer head first, and 0.5mm increments. The last reamer head diameter should be 1mm larger than nail diameter. Another 0.5mm reaming can be applied if nail is hard to inserted.

NOTE: Do not ream in reverse direction, which may damage the reamer shaft.



Flexible Reamer Shaft (13030009)

10.ASSEMBLE THE PROXIMAL FEMORAL NAIL ON THE HANDLE

Same with PFNA-short.

RAMIC · PROXIMAL FEMORAL NAIL

SURGICAL TECHNIQUE

11. INSERT PROXIMAL FEMORAL NAIL

Same with PFNA-short. Only difference is insertion along the Guide Wire (13030008). Then remove the Guide Wire (13030008).



12. INSERT FEMORAL COMPRESSION SCREW

Same with PFNA-short

13. INSERT DISTAL LOCKING SCREW

Assemble Connector for Distal Aiming Arm, Left or Right, Distal Aiming Arm, adjustable (13031025) on the handle. Put the Radiopaque Stick (13030026) into the most distal hole on Distal Aiming Arm. Make the C arm 30°-60° to the sagittal plane, and 10°-35° to the coronal plane. To check whether the extension line of Radiopaque Stick (13030026) is exactly through the distal hole of femoral nail. If not, slightly adjust the green knob up side down to find the right position.

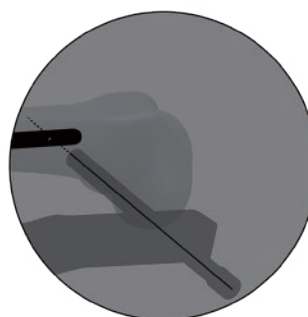
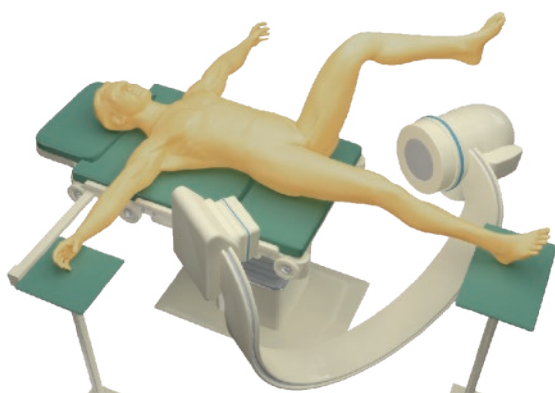
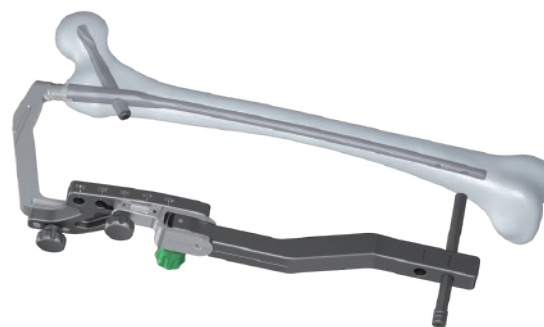

THE REMAINING PROCEDURES ARE SAME AS PFNA-SHORT.

RAMIC · PROXIMAL FEMORAL NAIL IMPLANTS

SHORT PROXIMAL FEMORAL NAIL

PRODUCT CODE 125°	PRODUCT CODE 130°	DIAMETER	LENGTH
55319017	55309017	φ9.0	170
55319020	55309020	φ9.0	200
55319024	55309024	φ9.0	240
55311017	55301017	φ10	170
55311020	55301020	φ10	200
55311024	55301024	φ10	240
55311117	55301117	φ11	170
55311120	55301120	φ11	200
55311124	55301124	φ11	240
55311217	55301217	φ12	170
55311220	55301220	φ12	200
55311224	55301224	φ12	240



LONG PROXIMAL FEMORAL NAIL

PRODUCT CODE LEFT	PRODUCT CODE RIGHT	DIAMETER	LENGTH
55309032	55319032	φ9.0	340
55309035	55319035	φ9.0	360
55309038	55319038	φ9.0	380
55309041	55319041	φ9.0	400
55309044	55319044	φ9.0	420
55301034	55311034	φ10	340
55301036	55311036	φ10	360
55301038	55311038	φ10	380
55301040	55311040	φ10	400
55301042	55311042	φ10	420
55301134	55311134	φ11	340
55301136	55311136	φ11	360
55301138	55311138	φ11	380
55301140	55311140	φ11	400
55301142	55311142	φ11	420
55301234	55311234	φ12	340
55301236	55311236	φ12	360
55301238	55311238	φ12	380
55301240	55311240	φ12	400
55301242	55311242	φ12	420



RAMIC · PROXIMAL FEMORAL NAIL

IMPLANTS

FEMORAL LOCKING SCREWS-A

PRODUCT CODE	DIAMETER	LENGTH
55030026	φ5.0	26
55030028	φ5.0	28
55030030	φ5.0	30
55030032	φ5.0	32
55030034	φ5.0	34
55030036	φ5.0	36
55030038	φ5.0	38
55030040	φ5.0	40
55030042	φ5.0	42
55030044	φ5.0	44
55030046	φ5.0	46
55030048	φ5.0	48
55030050	φ5.0	50
55030052	φ5.0	52
55030054	φ5.0	54
55030056	φ5.0	56
55030058	φ5.0	58
55030060	φ5.0	60
55030062	φ5.0	62
55030064	φ5.0	64
55030066	φ5.0	66
55030068	φ5.0	68
55030070	φ5.0	70
55030072	φ5.0	72
55030074	φ5.0	74
55030076	φ5.0	76
55030078	φ5.0	78
55030080	φ5.0	80



FEMORAL HIP COMPRESSION SCREW -A

PRODUCT CODE	LENGTH
55320070	70
55320075	75
55320080	80
55320085	85
55320090	90
55320095	95
55320100	100
55320105	105
55320110	110
55320115	115
55320120	120



FEMORAL HIP COMPRESSION SCREW -B

PRODUCT CODE	LENGTH
55360070	70
55360075	75
55360080	80
55360085	85
55360090	90
55360095	95
55360100	100
55360105	105
55360110	110
55360115	115
55360120	120



PROXIMAL FEMORAL END CAPS

PRODUCT CODE	LENGTH
55350000	0
55350005	5
55350010	10
55350015	15



FASTENING SCREW

PRODUCT CODE
55370000



BONE CEMENT

PRODUCT CODE
S71700000







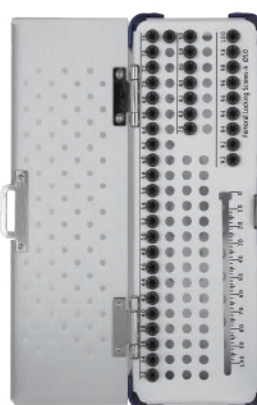
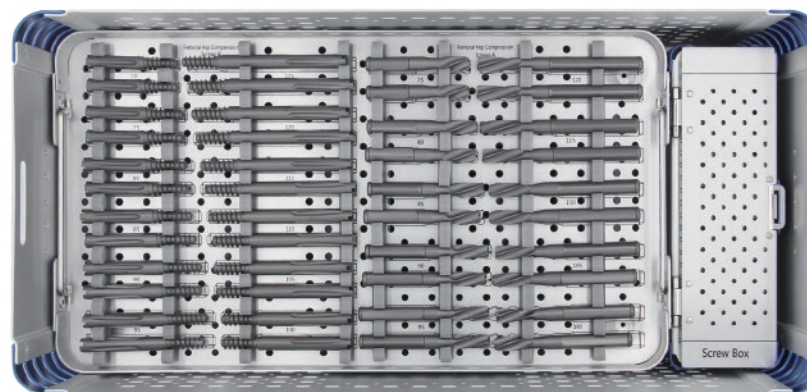
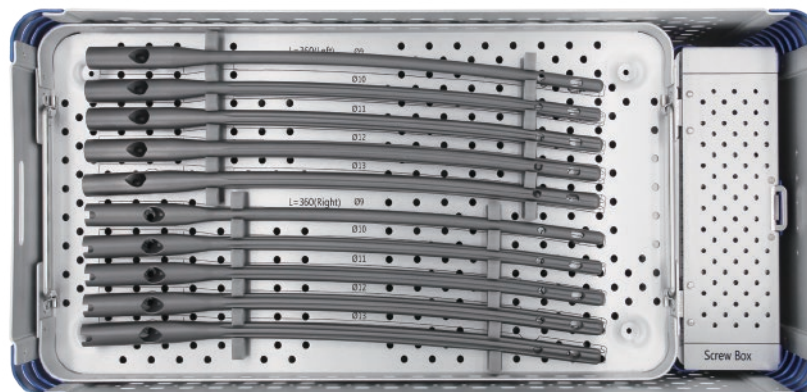
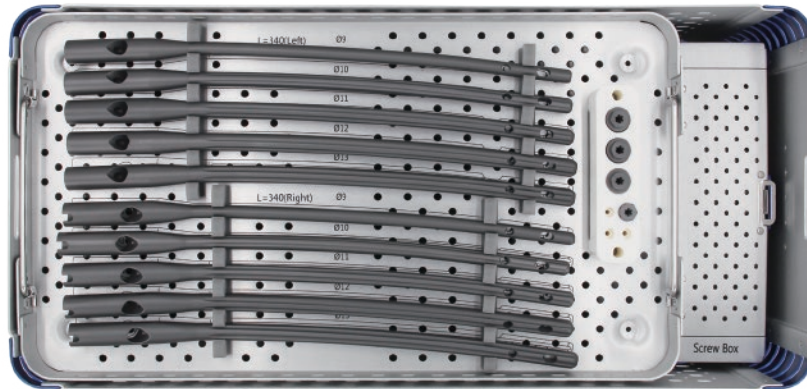





RAMIC · PROXIMAL FEMORAL NAIL IMPLANTS

IMPLANT PLACEMENT STATUS















RAMIC · PROXIMAL FEMORAL NAIL

INSTRUMENTS

PRODUCT CODE	PARTS DESCRIPTION	QUANTITY	PICTURE
13031001	Entry Drill Guide	1	
13031002	Entry Drill sleeve for Guide wire	1	
13030059	φ3.2 Threaded Guide Wire-B	4	
13031003	Entry Reamer,Cannulated	1	
13030006	Quick Handle	1	
13030019	Impactor	1	
13031004	Insertion Handle	1	
13031005	Locking Bolt	2	
13031006	Proximal Aiming Device,130°	1	
13031007	Proximal Aiming Device,125°	option	





RAMIC · PROXIMAL FEMORAL NAIL

INSTRUMENTS

PRODUCT CODE	PARTS DESCRIPTION	QUANTITY	PICTURE
13031008	Protection Sleeve for Lag Screw	1	
13031009	Aiming Arm for dynamic locking	1	
13031010	Compression Instrument for Blade	1	
13030033	Hexagonal Screwdriver with spherical head, SW7	1	
13031012	Aiming Jig for Anti-rotation Wire	1	
13031013	Drill sleeve	1	
13031014	Drill sleeve for $\varnothing 3.2$ Guide Wire	1	
13031015	Trocar, $\varnothing 3.2$	1	
13031016	Depth Gauge for Lag Screw	1	
13031017	Drill Bit for opening Proximal cortical bone, Cannulated	1	
13031018	Proximal Reamer, Cannulated	1	
13031019	Impactor for Lag screws-A, Cannulated	1	
13030034	Sleeve for Locking Screw	2	









RAMIC · PROXIMAL FEMORAL NAIL

INSTRUMENTS

PRODUCT CODE	PARTS DESCRIPTION	QUANTITY	PICTURE
13030035	Sleeve for Drill Bit	2	
13030036	Protector, $\varphi 4$	1	
13030037	Locating Pin	2	
13030038	Drill, $\varphi 4$	3	
13030039	Stopper for $\varphi 4$ Drill	2	
13030040	Depth Gauge for Locking Bolt	1	
13030041	Stardrive Wrench, Quick Coupling, $\Phi 5.6$	3	
13030047	Combined Hammer	1	
13030048	Combined Wrench	1	
13030052	Flexible Screwdriver for End Cap	1	
13030053	Uncal Guide Wire	1	
13030054	Flexible Screwdriver, $\Phi 5.6$	option	
13031020	Extractor for Lag Screws-A	1	













RAMIC · PROXIMAL FEMORAL NAIL

INSTRUMENTS

PRODUCT CODE	PARTS DESCRIPTION	QUANTITY	PICTURE
13031021	Helper for unscrewing from Extractor	1	
13031022	Extractor for Intramedullary Nail	1	
13030049	Hammer Guide	1	
13031023	Tap for Lag Screws-B	1	
13031024	Screwdriver for Lag Screws-B	1	
13030007	Instrument for Closed Reduction	1	
13030008	Guide wire with spherical head, φ2.5	1	
13030009	Flexible Reamer Shaft	1	
13030010	Flexible Reamer Head-φ9	1	
13030011	Flexible Reamer Head-φ9.5	1	
13030012	Flexible Reamer Head-φ10	1	
13030013	Flexible Reamer Head-φ10.5	1	
13030014	Flexible Reamer Head-φ11	1	
13030015	Flexible Reamer Head-φ11.5	1	
13030016	Flexible Reamer Head-φ12	1	
13030017	Flexible Reamer Head-φ12.5	1	
13030018	Flexible Reamer Head-φ13	1	

RAMIC · PROXIMAL FEMORAL NAIL

INSTRUMENTS

PRODUCT CODE	PARTS DESCRIPTION	QUANTITY	PICTURE
13030022	Connector for Distal Aiming Arm, Left	1	
13030023	Connector for Distal Aiming Arm, Right	1	
13031025	Distal Aiming Arm, adjustable	1	
13030026	Radiopaque Stick	1	
13031026	Awl-φ16	option	
13031027	channel for Bone Cement	option	
13031028	Cannula with Side-opening	option	
13030056	Radiographic Ruler for length	option	
13030057	Radiographic Ruler for diameter	option	
13030058	Guide wire Gripper	option	
13031029	Entry Drill Guide-B	option	
13031030	Entry Drill sleeve for Guide wire	option	

RAMIC · PROXIMAL FEMORAL NAIL

INSTRUMENTS

PRODUCT CODE	PARTS DESCRIPTION	QUANTITY	PICTURE
13030003	φ3.2 Threaded Guide Wire	option	
13031031	Entry Reamer, Femur-B	option	
13030060	Hexagonal Screwdriver with spherical head, SW7	option	
13031032	Flexible Screwdriver, Φ4.6	1	
13030069	Ruler For Nail's length	option	
13030075	Guide Wire Pusher	option	
13030076	Drill, 4.0-Short	option	
13030077	Depth Gauge for Locking Screw-Short	option	
13030078	Screwdriver for Locking Screw-Short	option	
13030063	T-type Awl	option	
13031991	Instrument Case	1	
13031995	implant Case	option	
13031996	Screw Case	option	

RAMIC · PROXIMAL FEMORAL NAIL INSTRUMENTS

INSTRUMENTS PLACEMENT STATUS

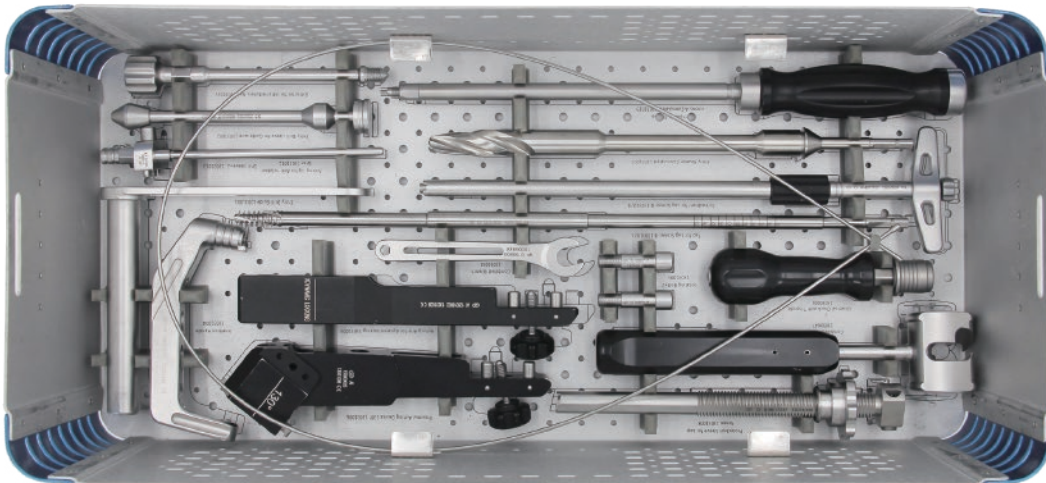
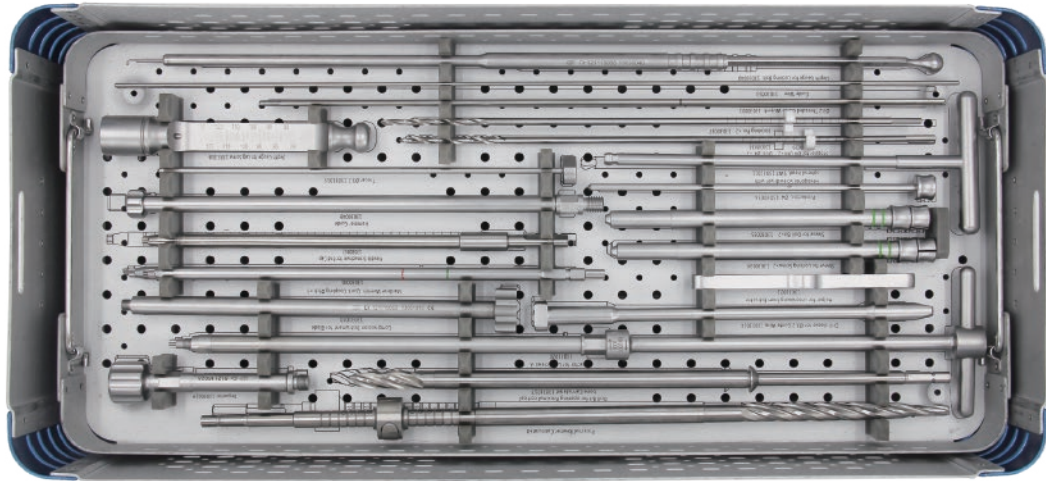

From our subsidiaries in Mexico, Argentina, Bolivia and Chile, we offer the most complete medical devices for trauma, spine, hip and knee.



Each product line has the certifications that comply with the regulations and sanitary registries in force in each country. We implement traceability and technovigilance procedures in the different stages of storage and commercialization. This rigorous control allows us to maintain a high brand value, guaranteeing highest safety for patients.

With more than 8 years dedicated to medical devices import and sale, we stand out for our service, clinical efficiency products and competitive costs.

To find out more about our medical devices, please contact us to link you to the closest supplier to your location.



MEXICO
Amores 1322
Colonia del Valle Centro
Benito Juarez 03100. CDMX.
+52 55 5925 5323
bioadvance.com.mx

ARGENTINA
Cnel. Cetz 336, Piso 2
Martínez B1642. San Isidro.
Provincia de Buenos Aires.
+54 11 7508 8730
bioadvance.com.ar

BOLIVIA
Calle Pedro Rodríguez 3830
Santa Cruz de la Sierra.
Bolivia.
+59 1 7048 5050
bolivia.bioadvanceusa.com

CHILE
Av. Santa María 2670 Of. 503
Providencia 7520424.
Región Metropolitana. Santiago de Chile.
+56 2 6465 9897
chile.bioadvanceusa.com



OVERFIX[®]
— TRAUMA —

bioadvance
— MEDICAL DEVICES —

MÉXICO

bioadvance.com.mx

ARGENTINA

bioadvance.com.ar

BOLIVIA

bolivia.bioadvanceusa.com

CHILE

chile.bioadvanceusa.com